

PRODUCT DATASHEET

DL ALU DN 200 35 W 4000 K IP44 WT

DOWNLIGHT ALU | Downlight luminaires with aluminum housing



AREAS OF APPLICATION

- Direct replacement for luminaires with fluorescent lamps
- General illumination
- Public areas
- Stairways
- Corridors
- Foyers
- Shops

PRODUCT BENEFITS

- High luminous efficacy
- Energy savings up to 60 % (compared to luminaires that use CFL lamps)
- Very homogenous light
- Functional design
- Easy installation with fast connection
- External driver for extended flexibility (compatible with selected DALI drivers)
- 5 years guarantee

PRODUCT FEATURES

- Diameter of required ceiling cut-out: 150 mm or 200 mm (depending on version)
- Type of protection: IP44



TECHNICAL DATA

Electrical data

Nominal wattage	35.00 W
Operating mode	External LED driver
Nominal voltage	220...240 V
Power factor λ	>0.90
Mains frequency	50/60 Hz

Luminaire control gear data

Ouput current	27...42 mA
ECG - Output ripple current	<35 %
ECG - Length	138 mm
ECG - Width	45 mm
Max. no. of lum. on circuit break. B16 A	67
Max. no. of lum. on circuit break. C10 A	50
Max. no. of lum. on circuit break. C16 A	100

Photometrical data

Color temperature	4000 K
Luminous flux	3150 lm
Luminous efficacy	90 lm/W
Standard deviation of color matching	≤ 6 sdc _m
Light color (designation)	Cool White
Color rendering index Ra	>80

Light technical data

Beam angle	100.00 °
------------	----------

Dimensions & weight

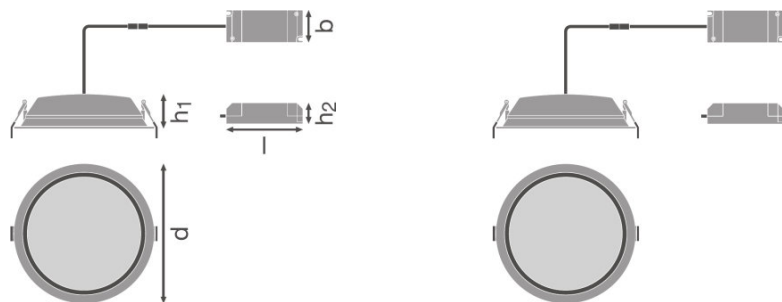

Diameter	215.0 mm
Height	61.0 mm
Product weight	600.00 g
Mounting diameter	200.0 mm

Colors & materials

Body material	Aluminum
Housing color	White
Product color	White
Cover material	Polymethylmethacrylate (PMMA)

Temperatures & operating conditions

Ambient temperature range	-20...45 °C
----------------------------------	-------------

Lifespan

Lifespan L70 at 25 °C	50000 h
Lifespan L80 at 25 °C	45000 h
Lifespan L90 at 25 °C	30000 h
Number of switching cycles	100000

Additional product data

Mounting type	Recessed
Mounting location	Ceiling

Capabilities

Dimmable	No
Type of connection	Screw terminal, 2-Pole (L,N)
LED module replaceable	Not replaceable

Certificates & standards

Protection class IK (shock resistance)	IK02
Glow Wire Test according to IEC 695-2-1	650 °C
Photobio. safety group acc. to EN62471	RG 0
Protection class	II
Type of protection	IP44
Standards	CE/CB/ENEC/TÜV SÜD/RoHS

Light Distribution

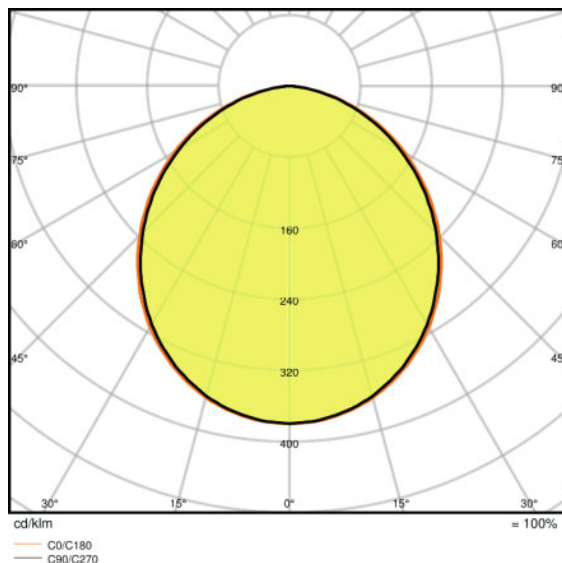
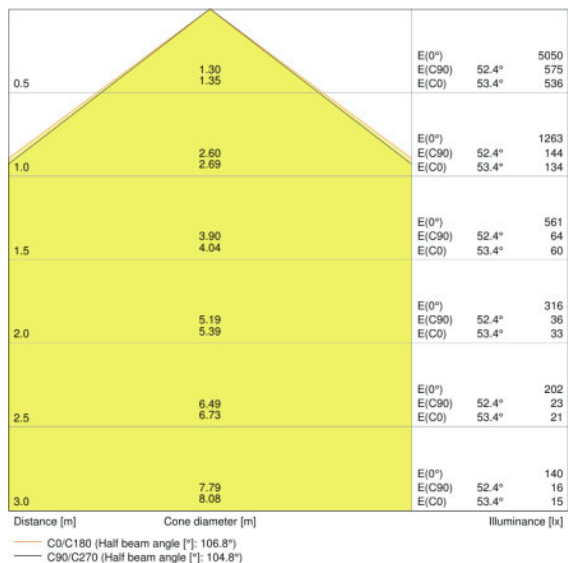

LDC typ cone

LDC typ polar

LOGISTICAL DATA

Product code	Product description	Packaging unit (Pieces/Unit)	Dimensions (length x width x height)	Volume	Gross weight
4058075091573	DL ALU DN 200 35 W 4000 K IP44 WT	Shipping carton box 8	462 mm x 462 mm x 240 mm	51.23 dm ³	6860.00 g

The mentioned product code describes the smallest quantity unit which can be ordered. One shipping unit can contain one or more single products. When placing an order, for the quantity please enter single or multiples of a shipping unit.

REFERENCES / LINKS

For Guarantee see
 ▶ www.ledvance.com/guarantee

DISCLAIMER

Subject to change without notice. Errors and omission excepted. Always make sure to use the most recent release.