



New Products 2020



Monospace are innovative new area floodlights with puristic design and precise optics. By combining wide beam and asymmetrical reflectors it is possible to choose the ideal light distribution for specific lighting applications. The luminaires are developed for use in urban spaces, pedestrian areas, streets and cycles paths. With neutral and timeless design Monospace can be harmoniously integrated into the landscape architecture.

The luminaires are available with wall mounting brackets or with pole-top fitters. The smooth housing surface is dirt repellent and easy to maintain.

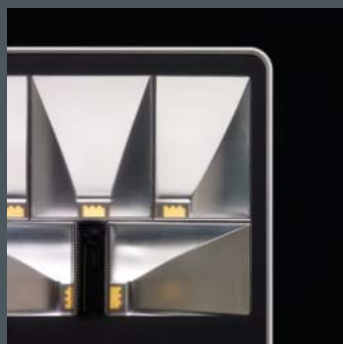
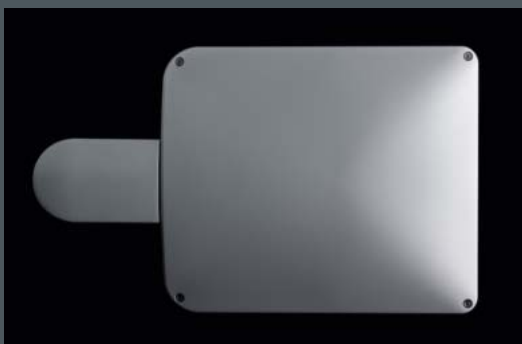





Pole-top luminaires are available complete with one or two floodlights. With a choice of various different light distributions and wattages this configuration can be adapted to a distinct lighting task. The units are pre-assembled for easy installation.

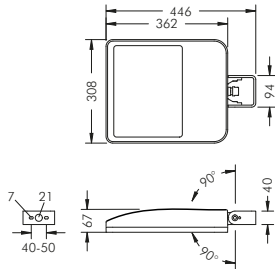

The neutral and functional design of Monospace is compatible with many different architectural environments.



Monospace with wall bracket

With highly efficient LED modules, integral temperature monitoring device, CRI: > 80, Colour tolerance: max. 3 SDCM
 Service life: L80/B20 > 50 000 h
 protection class I, IP65 , IK08
 windage area AW 0.026 m²
 corrosion-resistant die cast aluminium housing AlSi12, polyester powder coated, highly efficient metallized PC reflector, all exterior steel parts are stainless steel, tempered safety glass, silicon gasket, 4 stainless steel screws, front frame with anti-drop device, mounting bracket: 2 drilled holes Ø 7 mm, spacing 40 - 50 mm, 1 centre hole Ø 21 mm, tilt range 180°, M20 cable gland, integral driver

Monospace, asymmetrical beam

Part number*	Colour	Weight	Light source	Luminous flux	Main beam angle γ
8 250 046 049	black	4.5 kg	4 x LED module 11.5 W (46 W) warm white (3000 K)	5618 lm	58°
8 250 066 049	white				
8 250 056 049	silver grey				

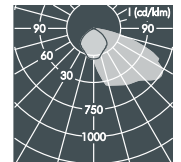
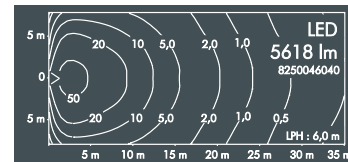

Monospace, asymmetrical beam, High Output

Part number*	Colour	Weight	Light source	Luminous flux	Main beam angle γ
8 251 046 049	black	4.8 kg	4 x LED module 20 W (80 W) warm white (3000 K)	9041 lm	58°
8 251 066 049	white				
8 251 056 049	silver grey				

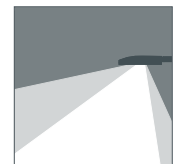
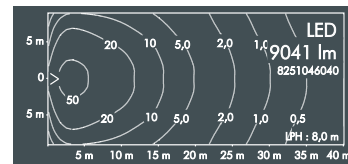

Monospace, asymmetrical wide beam

Part number*	Colour	Weight	Light source	Luminous flux	Beam angle γ (FWHM)	
					C 0 - 180	C 90 - 270
8 250 046 089	black	4.5 kg	5 x LED module 10.8 W (54 W) warm white (3000 K)	6643 lm	C 0 - 180	C 90 - 270
8 250 066 089	white				60°	138°
8 250 056 089	silver grey					

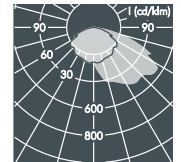
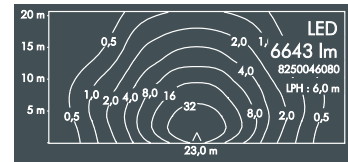

Monospace, asymmetrical wide beam, High Output

Part number*	Colour	Weight	Light source	Luminous flux	Beam angle γ (FWHM)	
					C 0 - 180	C 90 - 270
8 251 046 089	black	4.8 kg	5 x LED module 16 W (80 W) warm white (3000 K)	9120 lm	C 0 - 180	C 90 - 270
8 251 066 089	white				60°	138°
8 251 056 089	silver grey					

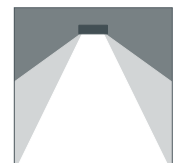
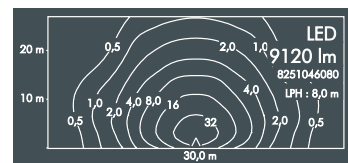

Monospace, lateral wide beam

Part number*	Colour	Weight	Light source	Luminous flux	Beam angle γ (FWHM)	
					C 0 - 180	C 90 - 270
8 250 046 059	black	4.5 kg	4 x LED module 11.5 W (46 W) warm white (3000 K)	5635 lm	C 0 - 180	C 90 - 270
8 250 066 059	white				33°	148°
8 250 056 059	silver grey					

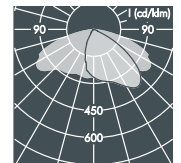
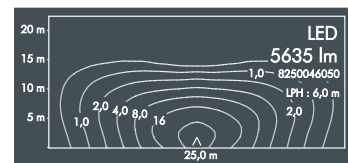

Monospace, lateral wide beam, High Output

Part number*	Colour	Weight	Light source	Luminous flux	Beam angle γ (FWHM)	
					C 0 - 180	C 90 - 270
8 251 046 059	black	4.8 kg	4 x LED module 20 W (80 W) warm white (3000 K)	9082 lm	C 0 - 180	C 90 - 270
8 251 066 059	white				33°	148°
8 251 056 059	silver grey					

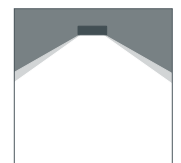
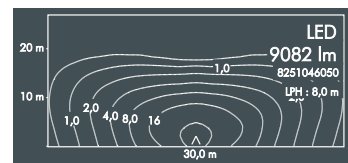

Monospace, Comfort Optic

Part number*	Colour	Weight	Light source	Luminous flux	Beam angle γ (FWHM)	
					C 0 - 180	C 90 - 270
8 250 046 009	black	4.6 kg	1 x LED Prism module 55 W warm white (3000 K)	3971 lm	C 0 - 180	C 90 - 270
8 250 066 009	white				71°	139°
8 250 056 009	silver grey					

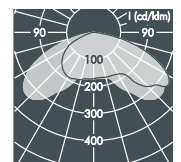
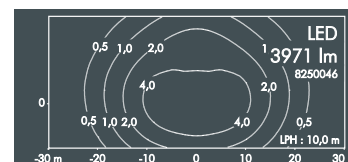

Part number	Description
... .. 5 ...	Luminaire with neutral white colour temperature (4000 K)
... .. 1 ..	Dimmable luminaire (DALI)

LED

Luminaires available in 2700 K and other colour temperatures upon request



Monospace pole-top luminaire, single configuration

With highly efficient LED modules,
 integral temperature monitoring device,
 CRI: > 80, Colour tolerance: max. 3 SDCM
 Service life: L80/B20 > 50 000 h
 protection class I, IP65 , IK08
 windage area AW 0.038 m²
 corrosion-resistant die cast aluminium housing AlSi12,
 polyester powder coated,
 highly efficient metallized PC reflector,
 all exterior steel parts are stainless steel,
 tempered safety glass, silicon gasket,
 4 stainless steel screws,
 front frame with anti-drop device,
 with pole top fitter for 1 luminaire for
 poles Ø 60/76 mm, 3 M8 grub screws,
 tilt range 7°, M20 cable gland,
 with 8 m cable H05RN-F3G1,
 integral driver

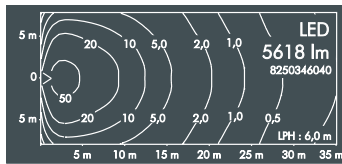
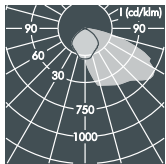
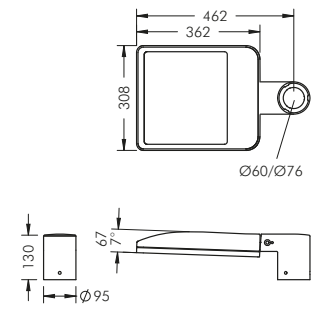

Monospace pole-top luminaire, single configuration, asymmetrical beam

Part number*	Colour	Weight	Light source	Luminous flux	Main beam angle γ
8 250 346 049	black	5.1 kg	4 x LED module 11.5 W (46 W) warm white (3000 K)	5618 lm	58°
8 250 366 049	white				
8 250 356 049	silver grey				

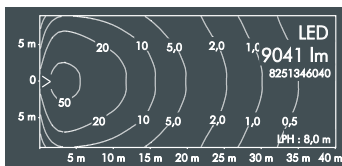

Monospace pole-top luminaire, single configuration, asymmetrical beam, High Output

Part number*	Colour	Weight	Light source	Luminous flux	Main beam angle γ
8 251 346 049	black	5.4 kg	4 x LED module 20 W (80 W) warm white (3000 K)	9041 lm	58°
8 251 366 049	white				
8 251 356 049	silver grey				

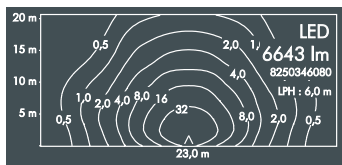
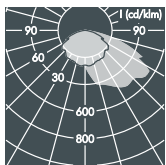

Monospace pole-top luminaire, single configuration, asymmetrical wide beam

Part number*	Colour	Weight	Light source	Luminous flux	Beam angle γ (FWHM)	
					C 0 - 180	C 90 - 270
8 250 346 089	black	5.1 kg	5 x LED module 10.8 W (54 W) warm white (3000 K)	6643 lm	60°	138°
8 250 366 089	white					
8 250 356 089	silver grey					

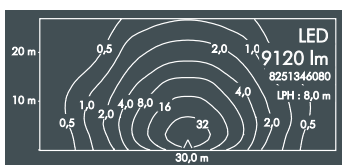
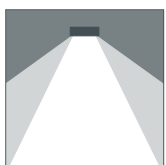

Monospace pole-top luminaire, single configuration, asymmetrical wide beam, High Output

Part number*	Colour	Weight	Light source	Luminous flux	Beam angle γ (FWHM)	
					C 0 - 180	C 90 - 270
8 251 346 089	black	5.4 kg	5 x LED module 16 W (80 W) warm white (3000 K)	9120 lm	60°	138°
8 251 366 089	white					
8 251 356 089	silver grey					

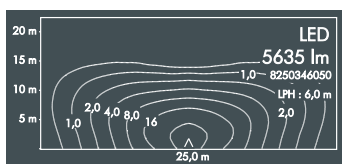
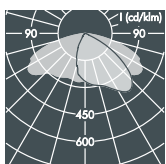

Monospace pole-top luminaire, single configuration, lateral wide beam

Part number*	Colour	Weight	Light source	Luminous flux	Beam angle γ (FWHM)	
					C 0 - 180	C 90 - 270
8 250 346 059	black	5.1 kg	4 x LED module 11.5 W (46 W) warm white (3000 K)	5635 lm	33°	148°
8 250 366 059	white					
8 250 356 059	silver grey					

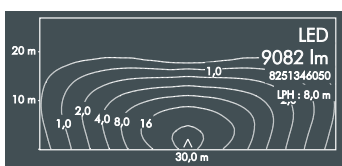
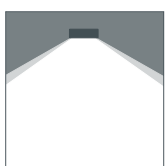

Monospace pole-top luminaire, single configuration, lateral wide beam, High Output

Part number*	Colour	Weight	Light source	Luminous flux	Beam angle γ (FWHM)	
					C 0 - 180	C 90 - 270
8 251 346 059	black	5.4 kg	4 x LED module 20 W (80 W) warm white (3000 K)	9082 lm	33°	148°
8 251 366 059	white					
8 251 356 059	silver grey					

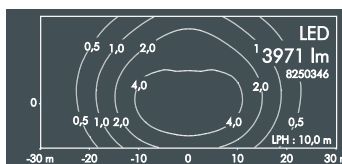
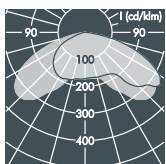

Monospace pole-top luminaire, single configuration, Comfort Optic

Part number*	Colour	Weight	Light source	Luminous flux	Beam angle γ (FWHM)	
					C 0 - 180	C 90 - 270
8 250 346 009	black	5.2 kg	1 x Prism module 55 W warm white (3000 K)	3971 lm	71°	139°
8 250 366 009	white					
8 250 356 009	silver grey					

Part number	Description
.....5...	Luminaire with neutral white colour temperature (4000 K)
.....1..	Dimmable luminaire (DALI)

*Additional dimming options and Zhaga 18-interface are available upon request.

LED

Luminaires available in 2700 K and other colour temperatures upon request



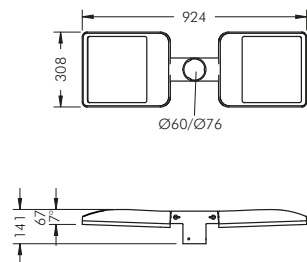

Monospace pole-top luminaire, double configuration

With highly efficient LED modules, integral temperature monitoring device, CRI: > 80, Colour tolerance: max. 3 SDCM
 Service life: L80/B20 > 50 000 h
 protection class I, IP65 , IK08
 windage area AW 0.063 m²
 corrosion-resistant die cast aluminium housing AlSi12, polyester powder coated,
 highly efficient metallized PC reflector, all exterior steel parts are stainless steel, tempered safety glass, silicon gasket, 4 stainless steel screws,
 front frame with anti-drop device, with pole top fitter for 2 luminaires for poles Ø 60/76 mm, 3 M8 grub screws, tilt range 7°, M20 cable gland, with 2 x 8 m cable H05RN-F3G1, integral driver

Monospace pole-top luminaire, double configuration, asymmetrical beam

Part number*	Colour	Weight	Light source	Luminous flux	Beam angle γ (FWHM)
8 250 446 049	black	9.7 kg	8 x LED module 11.5 W (92 W) warm white (3000 K)	11236 lm	58°
8 250 466 049	white				
8 250 456 049	silver grey				

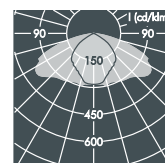
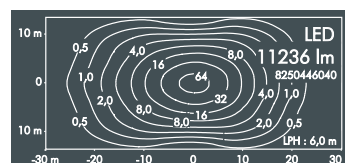

Monospace pole-top luminaire, double configuration, asymmetrical beam, High Output

Part number*	Colour	Weight	Light source	Luminous flux	Beam angle γ (FWHM)
8 251 446 049	black	10.3 kg	8 x LED module 20 W (160 W) warm white (3000 K)	18082 lm	58°
8 251 466 049	white				
8 251 456 049	silver grey				

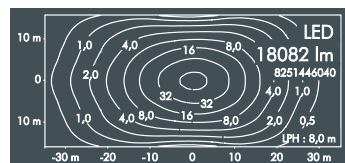

Monospace pole-top luminaire, double configuration, asymmetrical wide beam

Part number*	Colour	Weight	Light source	Luminous flux	Beam angle γ (FWHM)	
					C 0 – 180	C 90 – 270
8 250 446 089	black	9.7 kg	10 x LED module 10.8 W (108 W) warm white (3000 K)	13286 lm	60°	138°
8 250 466 089	white					
8 250 456 089	silver grey					

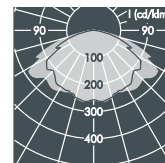
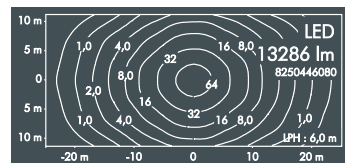

Monospace pole-top luminaire, double configuration, asymmetrical wide beam, High Output

Part number*	Colour	Weight	Light source	Luminous flux	Beam angle γ (FWHM)	
					C 0 – 180	C 90 – 270
8 251 446 089	black	10.3 kg	10 x LED module 16 W (160 W) warm white (3000 K)	18240 lm	60°	138°
8 251 466 089	white					
8 251 456 089	silver grey					

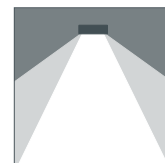
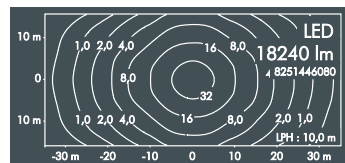

Monospace pole-top luminaire, double configuration, lateral wide beam

Part number*	Colour	Weight	Light source	Luminous flux	Beam angle γ (FWHM)	
					C 0 – 180	C 90 – 270
8 250 446 059	black	9.7 kg	8 x LED module 11.5 W (92 W) warm white (3000 K)	11270 lm	33°	148°
8 250 466 059	white					
8 250 456 059	silver grey					

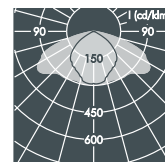
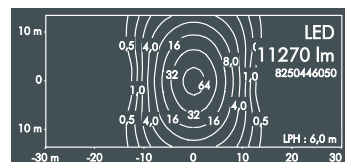

Monospace pole-top luminaire, double configuration, lateral wide beam, High Output

Part number*	Colour	Weight	Light source	Luminous flux	Beam angle γ (FWHM)	
					C 0 – 180	C 90 – 270
8 251 446 059	black	10.3 kg	8 x LED module 20 W (160 W) warm white (3000 K)	18164 lm	33°	148°
8 251 466 059	white					
8 251 456 059	silver grey					

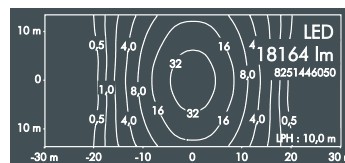

Monospace pole-top luminaire, double configuration, Comfort Optic

Part number*	Colour	Weight	Light source	Luminous flux	Beam angle γ (FWHM)	
					C 0 – 180	C 90 – 270
8 250 446 009	black	9.8 kg	2 x LED Prism module 55 W (110 W) warm white (3000 K)	7942 lm	71°	139°
8 250 466 009	white					
8 250 456 009	silver grey					

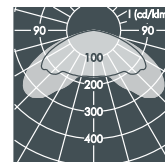
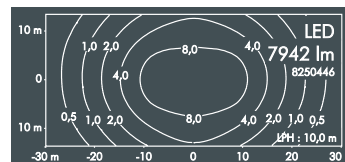

Part number	Description
... . 5 ...	Luminaire with neutral white colour temperature (4000 K)
... . . 1 ..	Dimmable luminaire (DALI)

LED

Luminaires available in 2700 K and other colour temperatures upon request



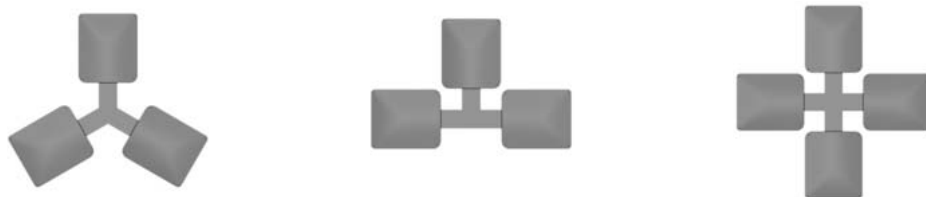

In addition to pole-top luminaires with single or double configurations custom-made versions with three or four luminaires are available upon request.

Illumination examples for Monospace pole-top luminaires with different light distributions

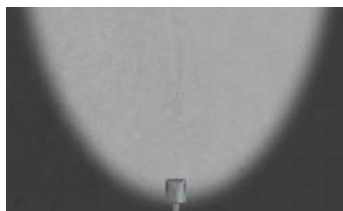
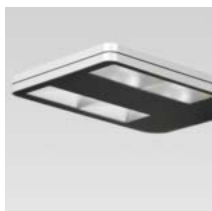

The asymmetrical beam optic with forward throw light distribution achieves high lux levels over a long distance in front of the luminaire.



With the asymmetrical wide beam optic uniform illumination on an area in front of and to both sides of the luminaire can be achieved.



The lateral wide beam optic directs light onto paths, streets and driveways and makes large luminaire spacings possible.

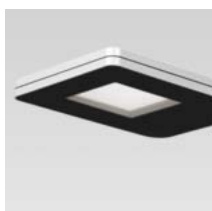

The Comfort Optic creates an even light distribution in front of and on both sides of the luminaire with optimal glare control.